

Monument Sign Cabinet (typ)

General Spec Sheet

- Aluminum Extrusion Frame System.
- LED Illuminated.
- Built for Center Pole.
- Fabricated Aluminum Base.



Standard - Center Pipe

▶ System DF1200 (Standard)

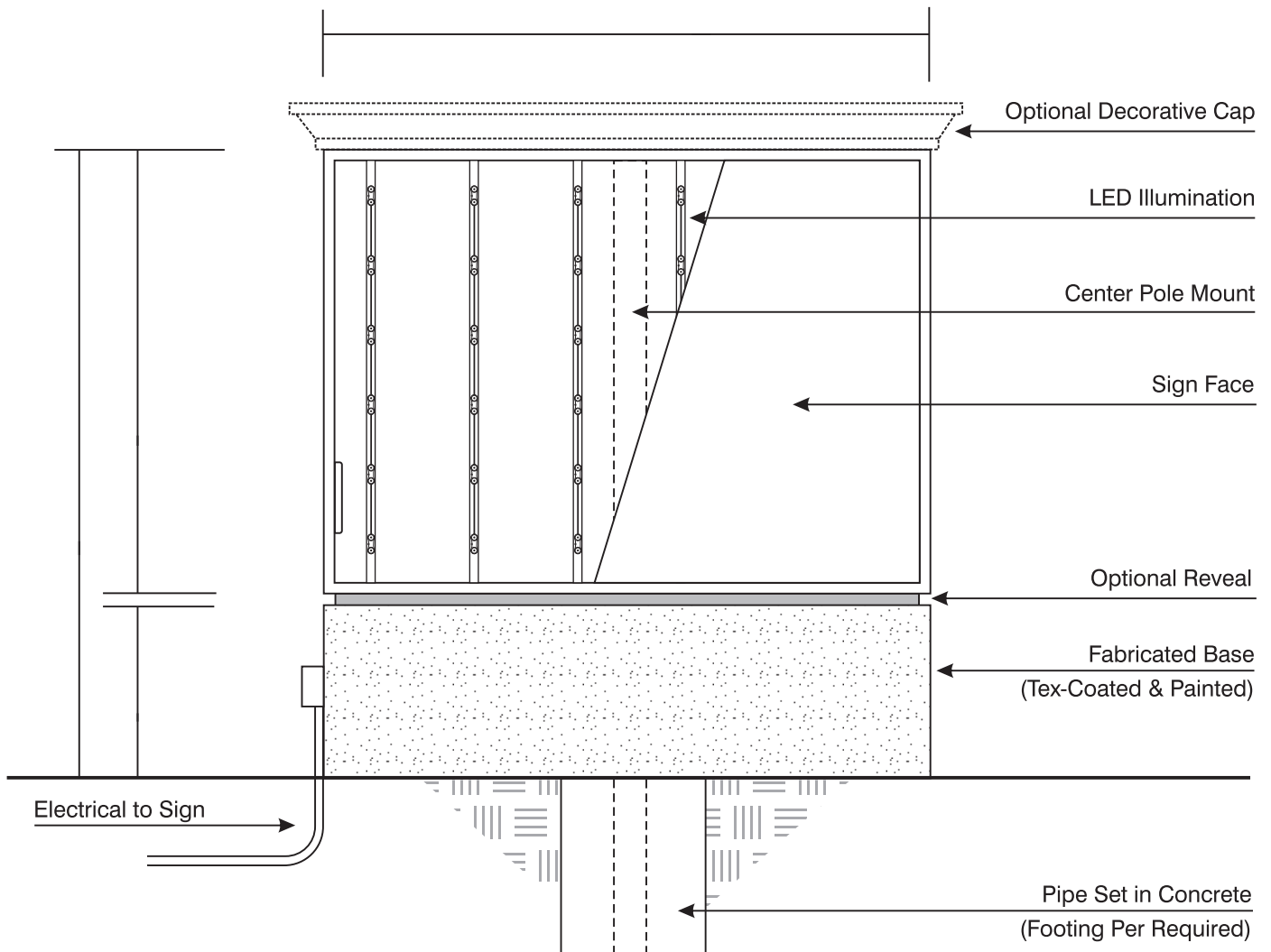
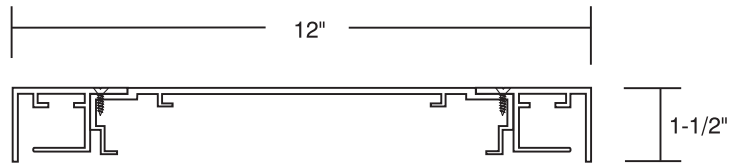

Monument Sign Cabinet (typ)

General Spec Sheet

- Aluminum Extrusion Frame System.
 - Aluminum Faces with Routes Face or Push Thru's
 - LED Illuminated.
 - Built for Center Pole.
- Fabricated Aluminum Base.



Routed Alum Faces

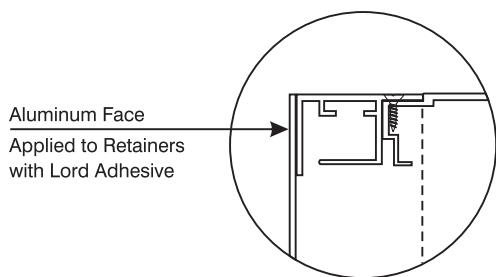

▶ System DF1200 (Standard)

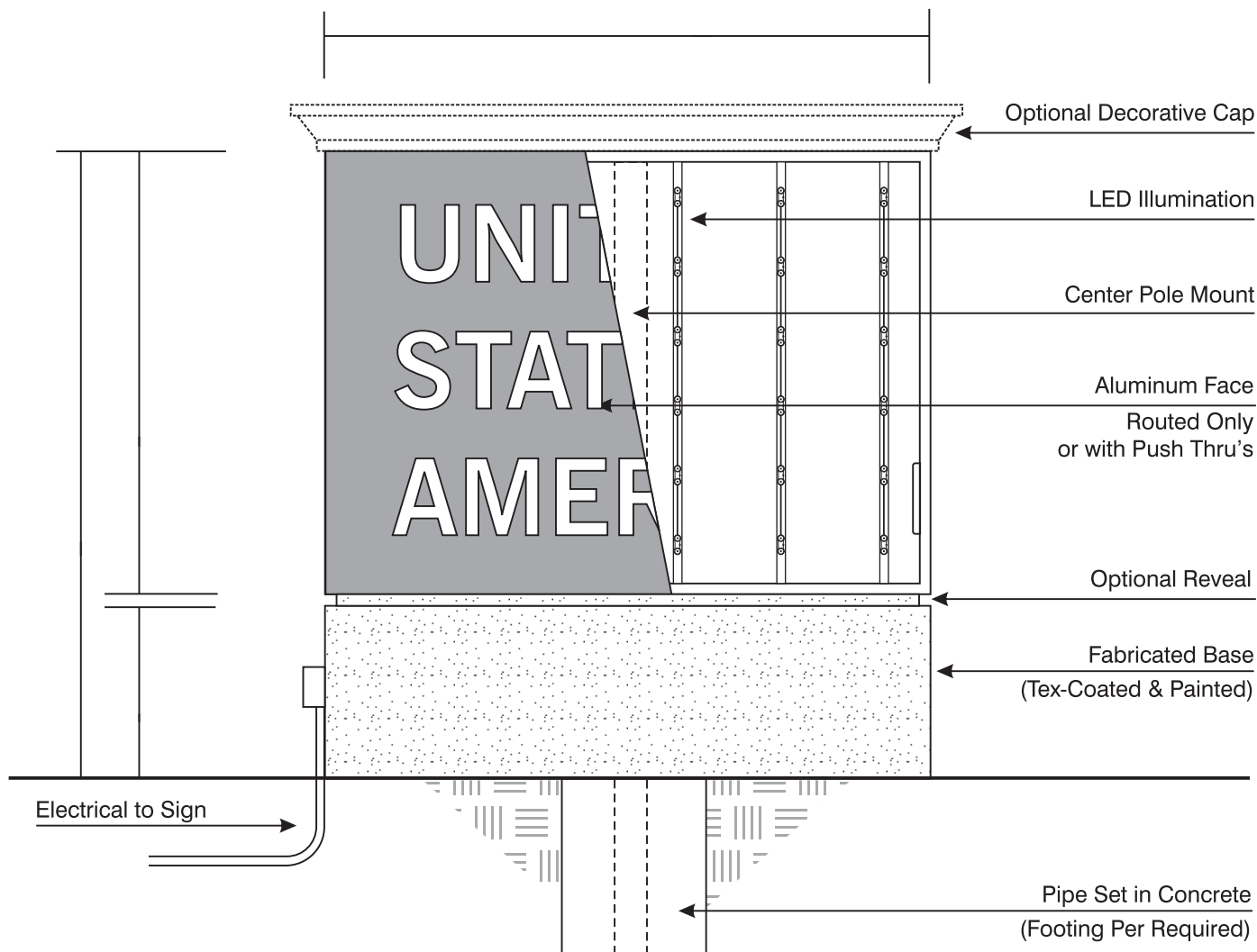
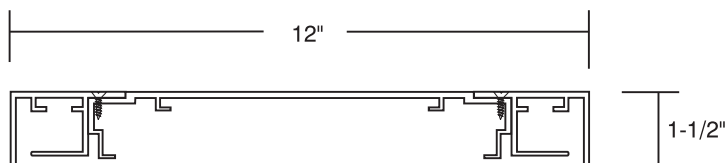

Monument Sign Cabinet (Bolt to Base)

General Spec Sheet

- Aluminum Extrusion Frame System.
- LED Illuminated.
- Built for Internal Pipes with Bolt Plates.
- Fabricated Aluminum Base.



Bolt to Concrete

► **System DF1200 (Standard)**

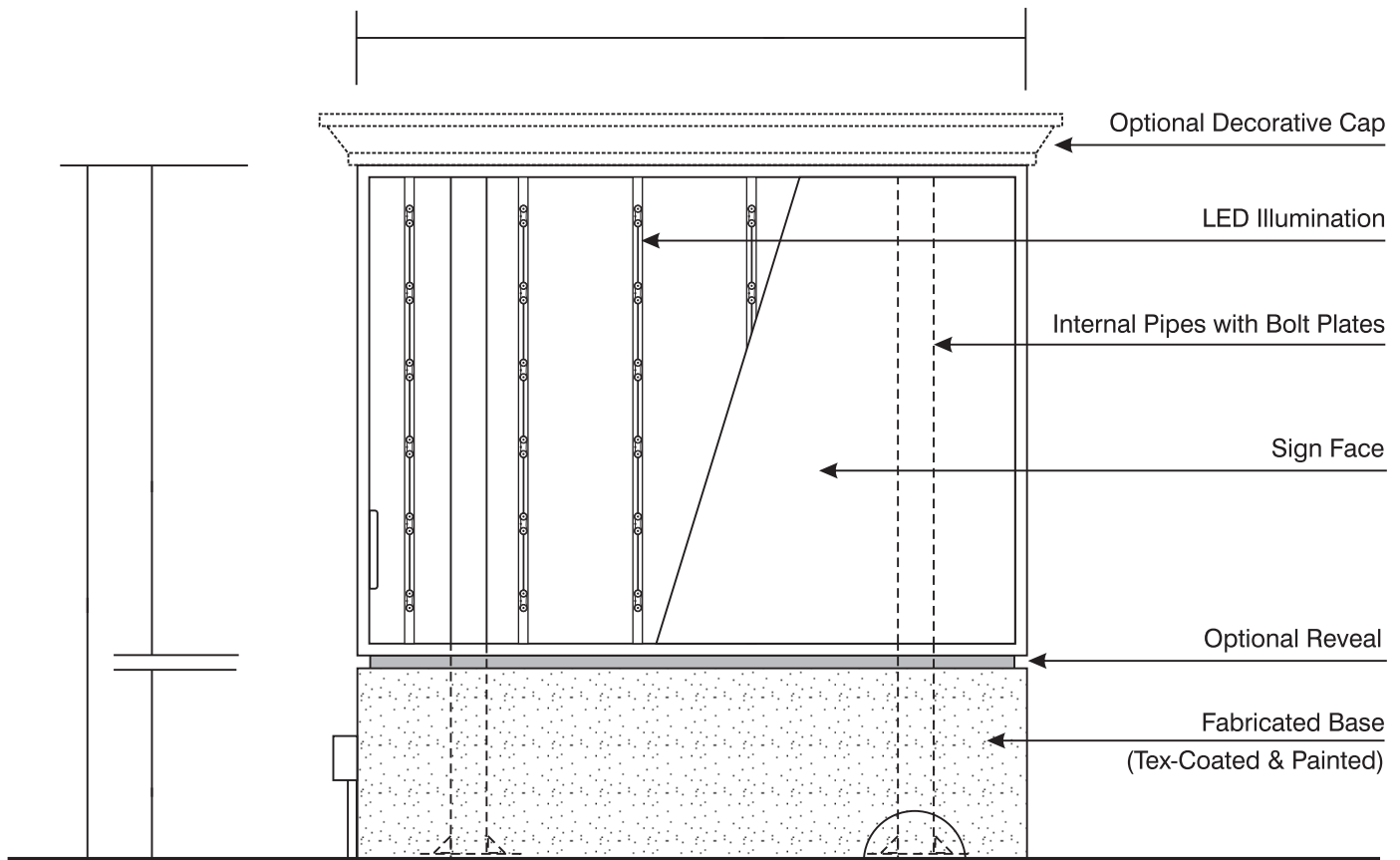
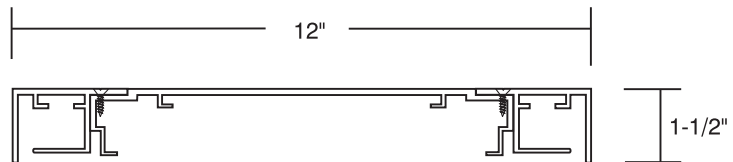

- Steel Pipe
- Steel Gussets
- Weld to Pipe & Plates
- Steel Bolt Plate
- Fasteners as Required for Concrete

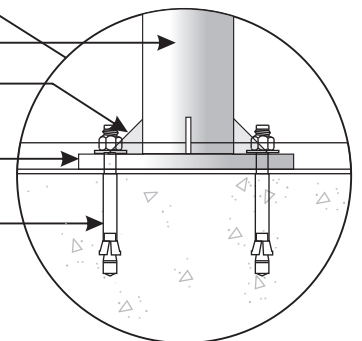

Monument Sign Cabinet (Bolt to Base)

General Spec Sheet

- Aluminum Extrusion Frame System.
- LED Illuminated.
- Built for Internal Pipes with Bolt Plates.



Bolt to Concrete

► **System DF1200 (Standard)**

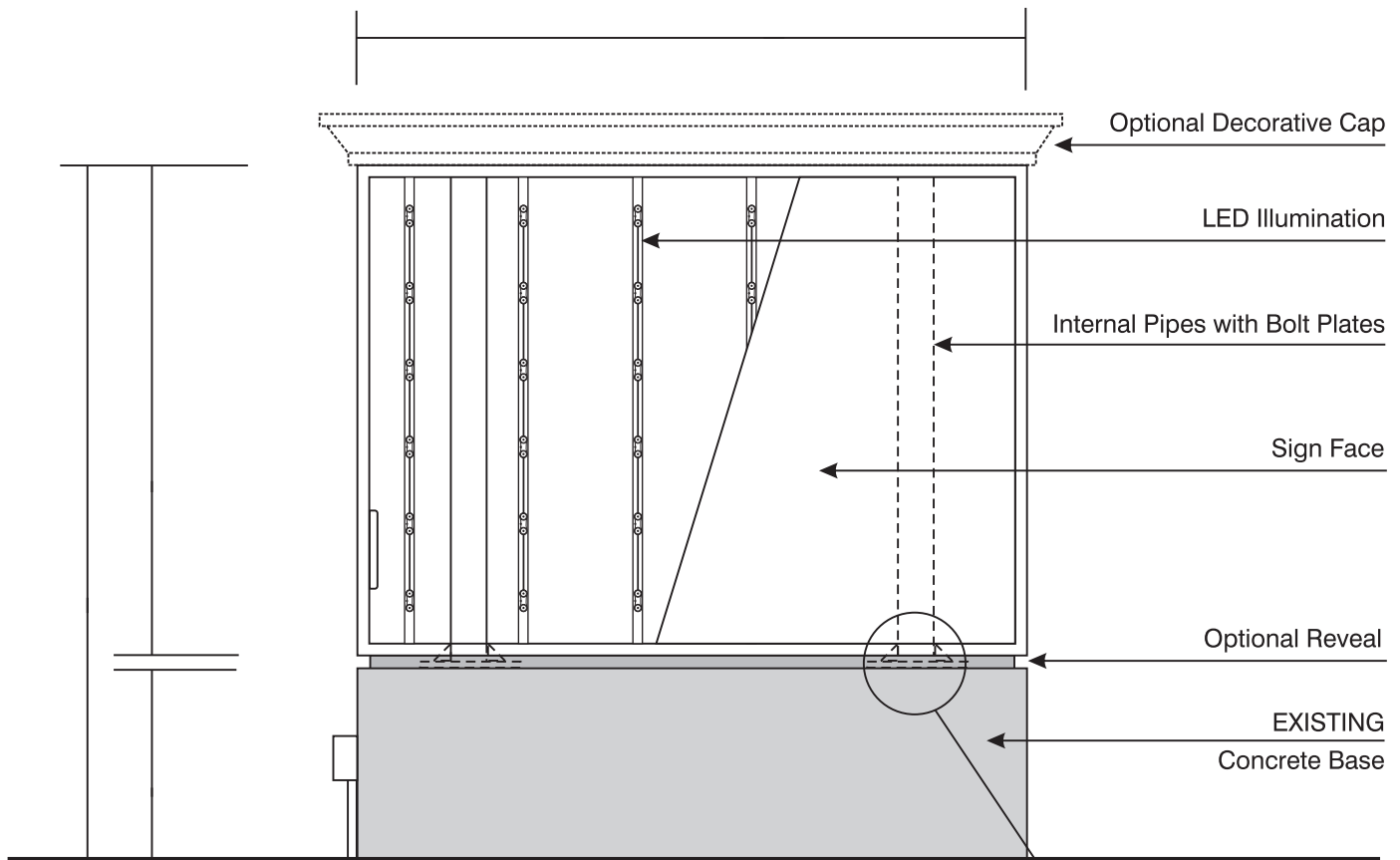
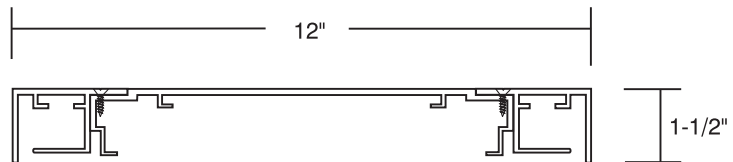

- Steel Pipe
- Steel Gussets
- Weld to Pipe & Plates
- Steel Bolt Plate
- Fasteners as Required for Concrete

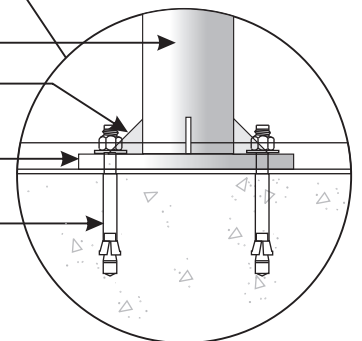

Monument Cabinets (Changeable Panels)

General Spec Sheet

- Aluminum Extrusion Frame System.
- LED Illuminated.
- Built for Center Pole.
- Fabricated Aluminum Base.
- Divider Bar for Changeable Faces.



Changeable Tenant Panels

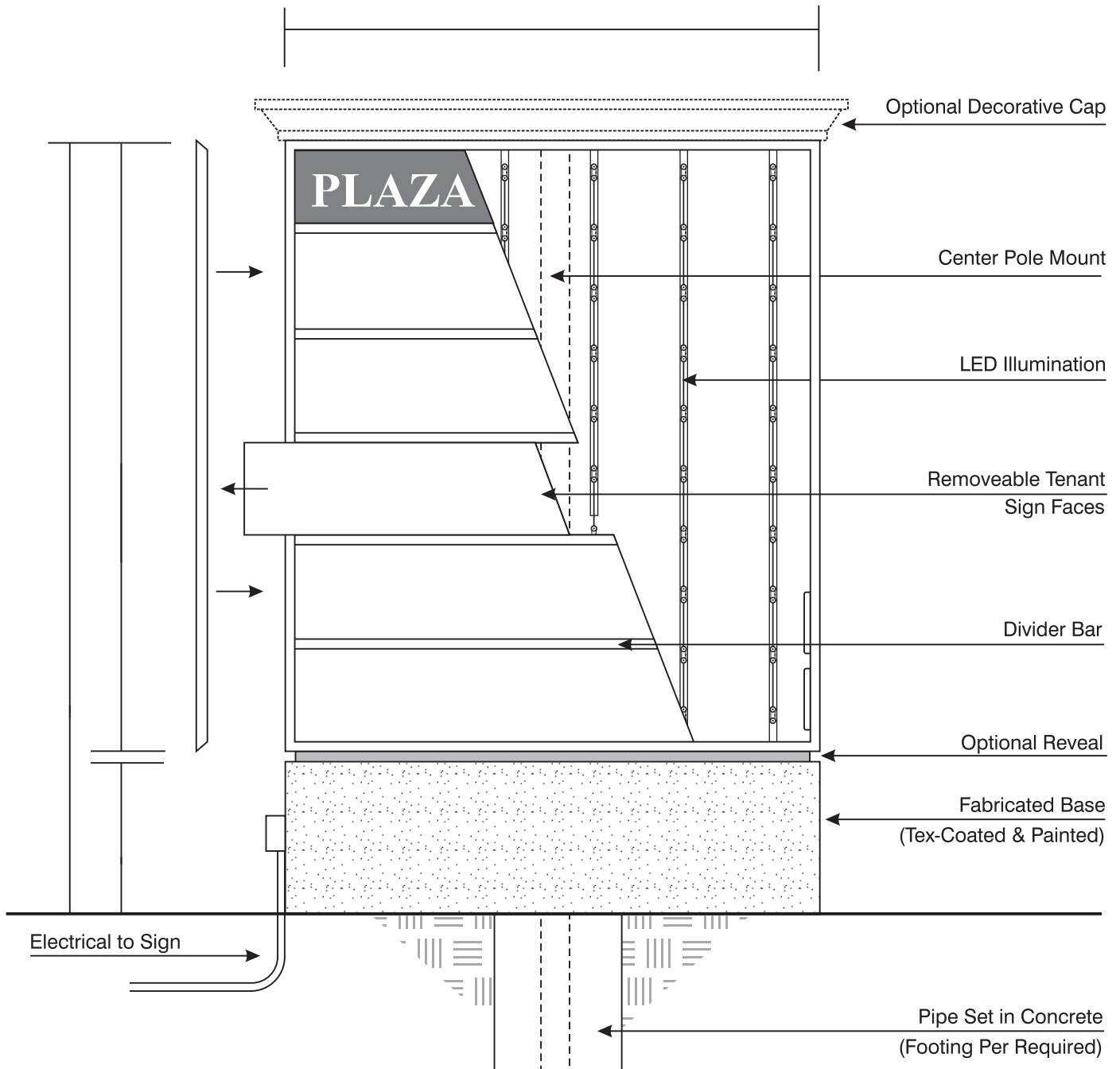

Sign Cabinets (Between Post Mount)

General Spec Sheet

- Aluminum Extrusion Frame System.
- LED Illuminated.
- External Sq. Tube Posts

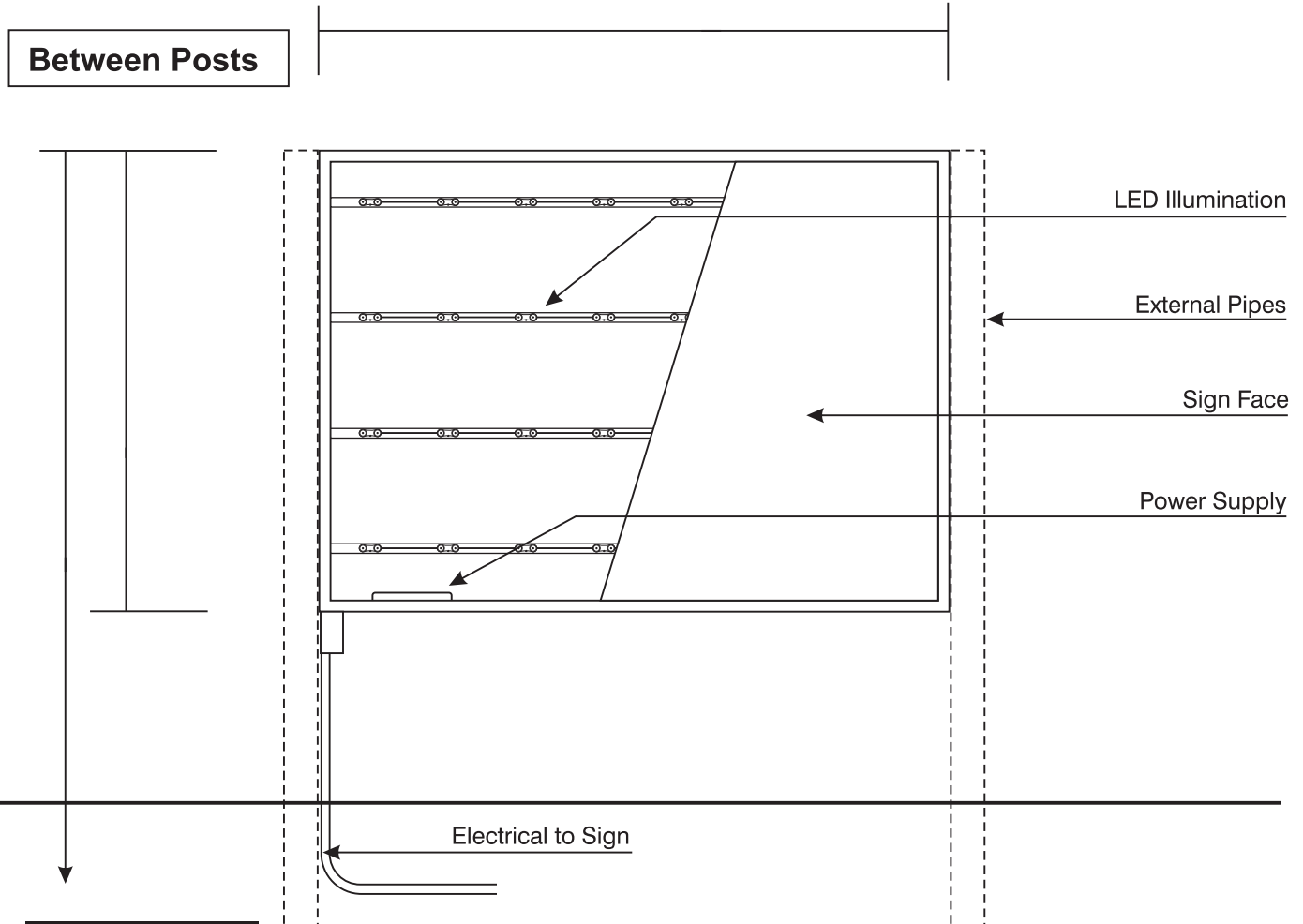

Frame Detail

▶ **System SF900 (Standard)**
 (For typical sign cabinet applications)

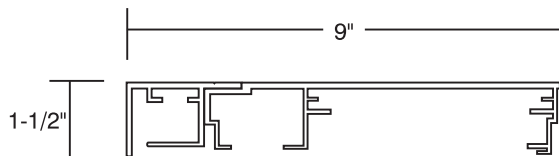

▶ **System SF775**
 (For smaller sign cabinet applications)

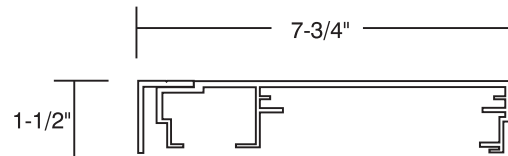

▶ **System DF1200 (Standard)**

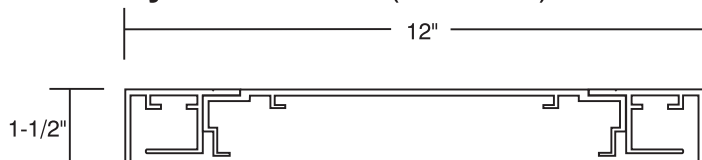

▶ **System DF950**

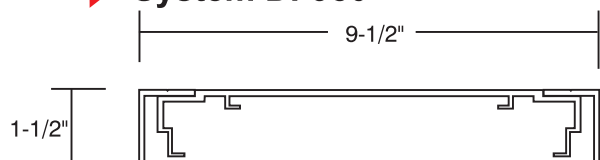

Monument Sign Cabinets (typ)

General Spec Sheet

- Aluminum Extrusion Frame System.
- Aluminum Faces
- Built for Center Pole.
- Fabricated Aluminum Base.

Non-Illum Std

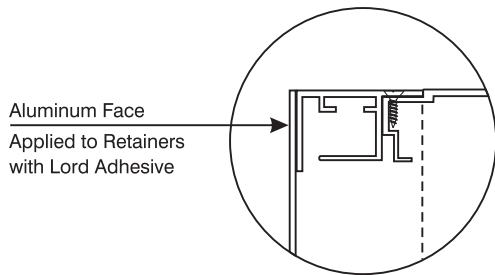

► System DF1200 (Standard)

